

PLM-180.1

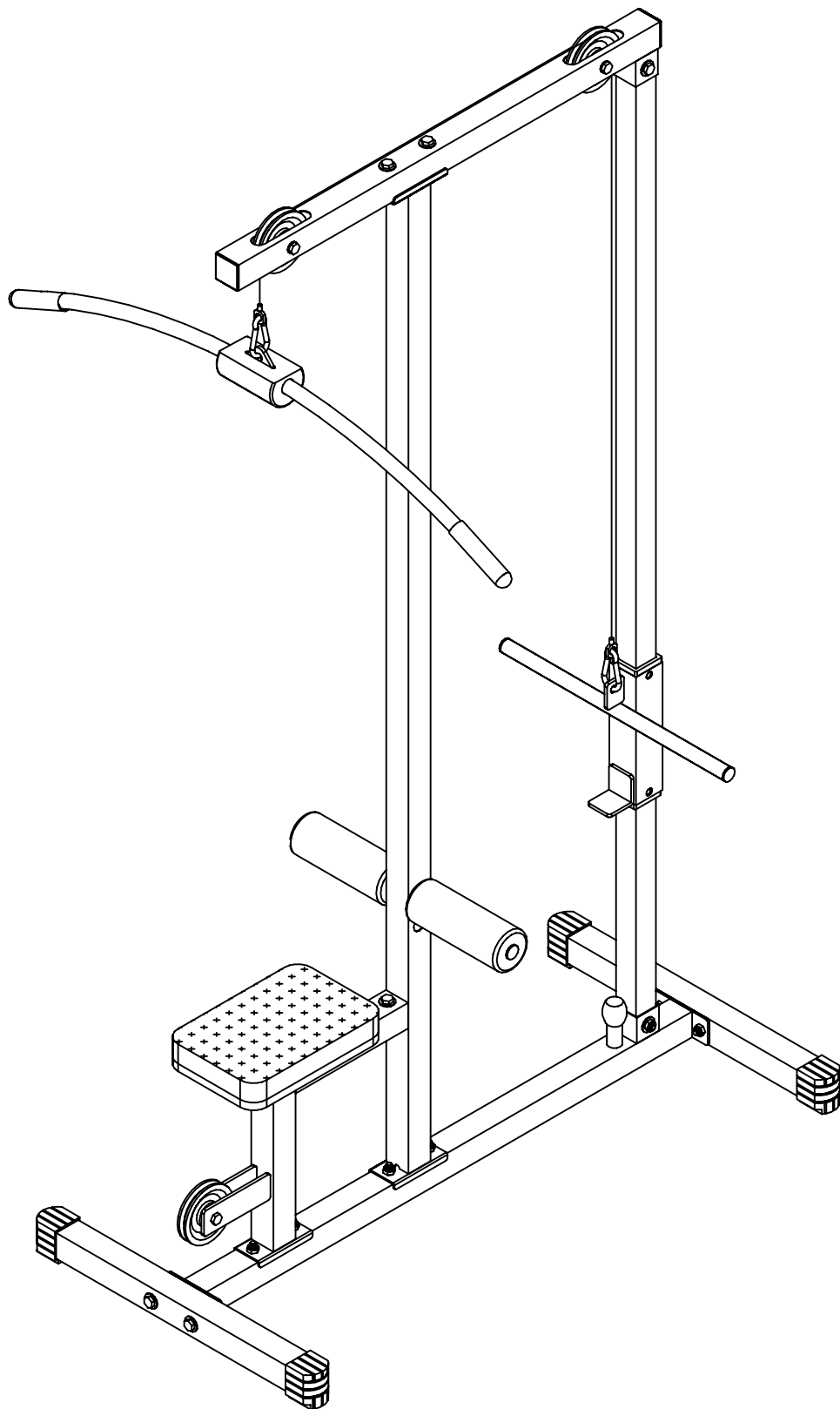





















VERSION 0508

PLM-180.1 HARDWARE ILLUSTRATION SHEET

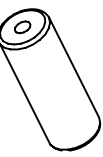
A1.	M10X70 HEX HEAD BOLT	[6PCS]
A2.	M10X70 CARRIAGE BOLT	[4PCS]
A3.	M10X65 HEX HEAD BOLT	[6PCS]
A4.	M8X16 HEX HEAD BOLT	[2PCS]
A5.	M10X45 HEX HEAD BOLT	[1PCS]
B1.	M10 NYLON LOCK NUT	[17PCS]
C1.	M10 (I.D) WASHER	[14PCS]
C2.	M8 (I.D) WASHER	[2PCS]
C3.	M8 SPRING WASHER	[2PCS]
D1.	ø6 SPRING SNAP LINK (8810-002)	[3PCS]
D2.	ø1"X130L RUBBER GRIP (9212-015)	[4PCS]
D3.	50X50 END CAP (9211-005)	[2PCS]
D4.	ø1" WEIGHT STOP CAP (9212-019)	[1PCS]
D5.	50X50 FOOT CAP (9212-003)	[4PCS]
D6.	ø16X16 STEEL BUSHING (9211-041)	[4PCS]
D7.	ø1" ROUND END CAP (9211-016)	[4PCS]
D8.	ø3"X8" FOAM ROLLER (9161-029A)	[2PCS]
D9.	ø110 PULLEY (9213-001)	[3PCS]
D10.	60X45 NYLON BUSHING (9211-032)	[2PCS]
D11.	2580mm LAT CABLE	[1PCS]
D12.	1900mm LOW ROW CABLE	[1PCS]

Qty.

A1		A2		A3		A4		A5	
B1		C1		C2		C3			
D1		D2		D3		D4		D5	
D6		D7		D8		D9			
D10		D11		D12					

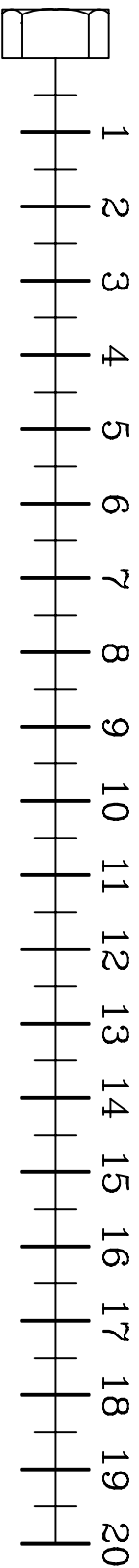

PLM-180.1 PARTS ILLUSTRATION SHEET

A [1PCS]

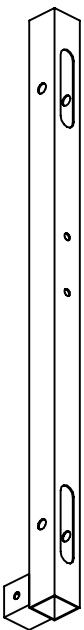

D [1PCS]

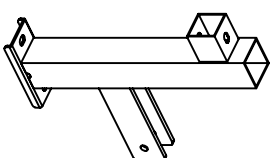

E [1PCS]

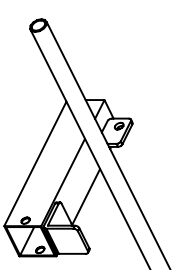

B [1PCS]

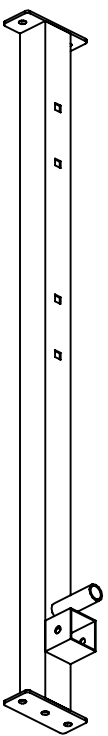

F [1PCS]

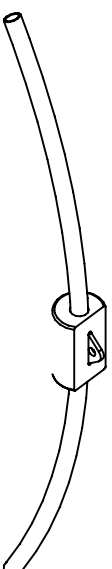

G [1PCS]



C [1PCS]

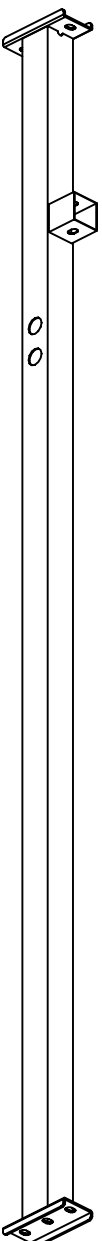

H [1PCS]



I [1PCS]

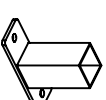

L [1PCS]



K [1PCS]



J [2PCS]

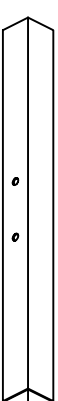

M [1PCS]

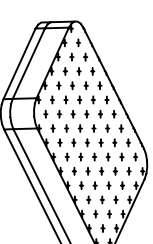

PLM-180.1

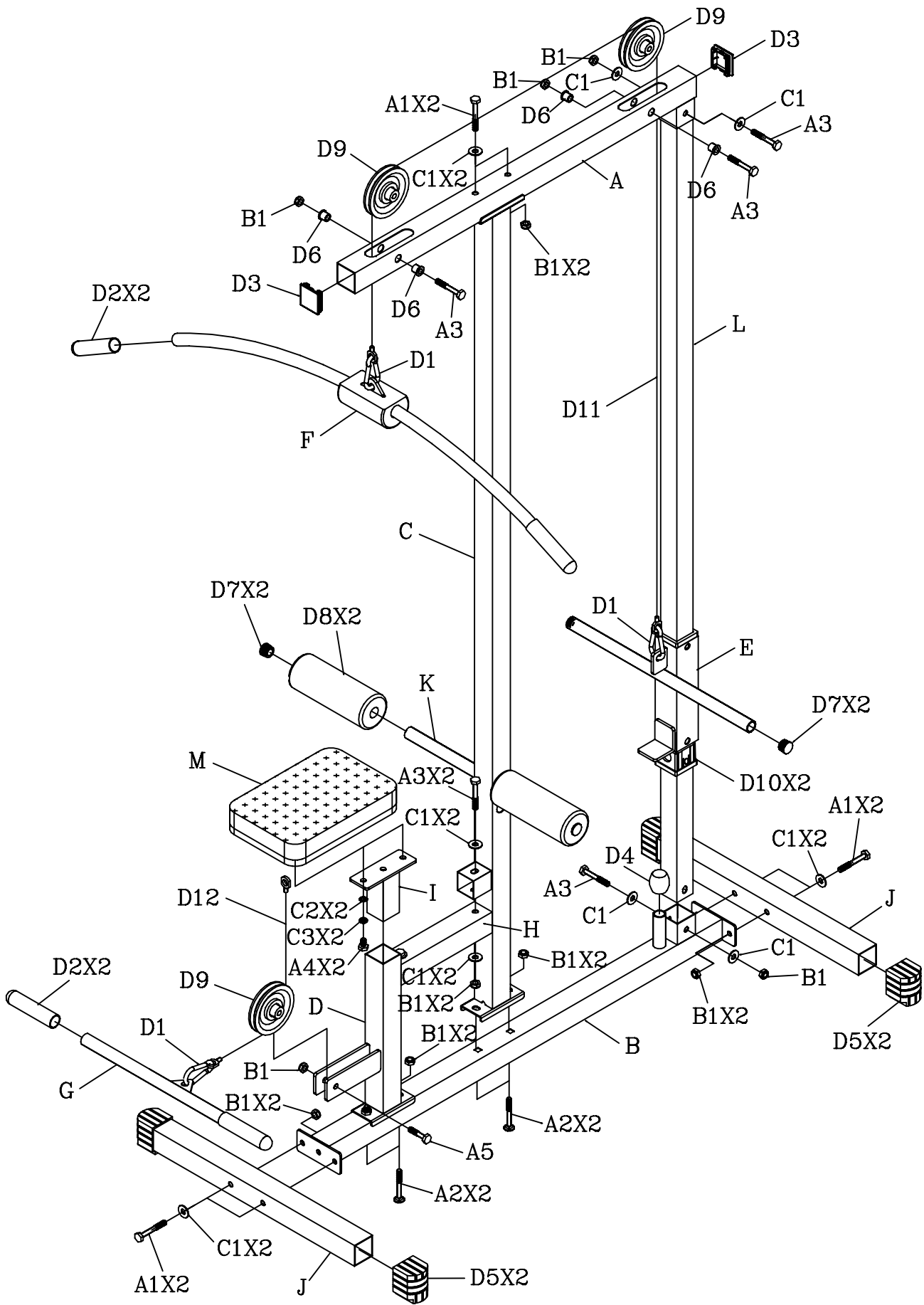

PLM-180.1

